

# PROLIST List of Properties – an Important Step Toward an Integrated Electronic Engineering and Business Workflow

## Abstract

Optimizing the engineering and business workflow with up-to-date computer programming languages is an important industrial challenge. This task has been tackled successfully by PROLIST® INTERNATIONAL. The current results of several years' work are published as NAMUR recommendation NE 100.

This document provides a method for standardizing the descriptions of process control devices and systems as well as their operating environments and operating requirements (e.g. specification data). Each device type is defined by a list of properties (LOP) containing the corresponding characteristics. This is a basic requirement for exchanging device information between different IT systems.

Use of the LOPs therefore supports data exchange between systems in a customer-supplier relationship and between systems within an organization, e.g. CAE or ERP systems. The NE 100 also enables storage of device data as LOPs in process control systems or field devices.

## Keywords

Property; list of properties (LOP) ; PROLIST; electronic data exchange; engineering process;

## 1. Introduction

The exchange of product data between various technical

disciplines and the corresponding process control systems (electrical, measuring and control technology) can only run smoothly when both the information to be exchanged and the use to which this information is to be put have been clearly defined. NE 100 makes an important contribution toward achieving this aim<sup>[1]</sup>.

In the past, the requirements on process control devices and systems were described in various ways by customers (users) when asking suppliers or manufacturers to recommend equipment. The suppliers in turn described the devices according to their own documentation and using different structures and media (paper, databases, CDs, e-catalogs, etc.). The situation was similar in the planning and development process, with device information frequently being duplicated in various IT systems.

Any method that is capable of recording all existing information only once during the planning and ordering process and making it available for all further processing gives everyone an opportunity to concentrate on the essentials. To achieve this both the descriptions of the objects and the exchange of information for all parties involved need to be standardized.

NAMUR recommendation NE 100 proposes a method for standardization which will help both suppliers and users of process control equipment and systems to optimize workflows both within their own companies and in their exchanges with other companies. Depending on their role in the process, engineering firms may be considered here to be either users or suppliers<sup>[2]</sup>. This context is illustrated in Figure 1

---

Literature:

[1] NE 100: 2006-08 "Use of Lists of Properties in Process Control Engineering Workflows"

[2] Zgorzelski, P.: "NE 100 – Version 3.0 und internationale Normung", Workshop presentation, NAMUR General Meeting 2006, Lahnstein

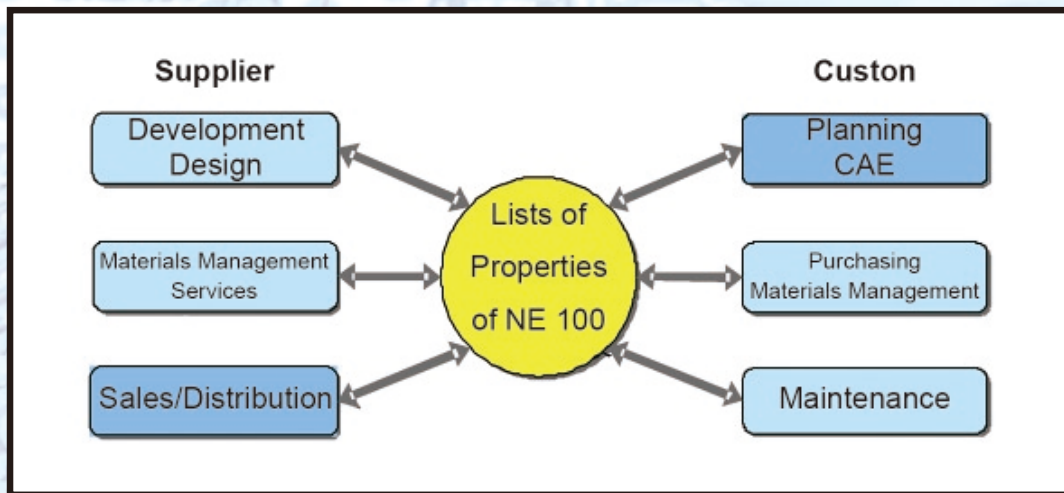

**Figure 1: Support for customer-supplier relations through NE 100**

Devices are specified using properties. These properties are compiled into lists of properties, each of which describes a specific device type. NE 100 covers both properties that may be used in an inquiry or a quotation and detailed properties required for integrating a process control device into systems for other tasks, such as planning (e.g. in CAE systems), maintenance and ERP systems.

PROLIST® INTERNATIONAL was founded at BASF in Ludwigshafen, Germany on June 19, 2008. It is the successor organization to the Project Group "Lists of Properties" (PROLIST®). PROLIST® INTERNATIONAL is a nonprofit and independent organization. The companies, and universities registered as PROLIST members can be found on its website at: [www.prolist.org](http://www.prolist.org).

The Project Group's aims are:

- To create and update characteristics and lists of properties (LOPs) for electrical and process control devices,
- To make LOPs immediately available to manufacturers and users through the NAMUR recommendation NE 100,
- To internationalize LOPs through an IEC standard.

NAMUR Recommendation 100, Version 3, which was published on August 31, 2006,<sup>[1]</sup> is entitled, "Using Lists of Properties in Process Control Engineering Workflows". In order to use the LOPs access is required to the PROLIST database from which all or some specific LOPs can be selected and downloaded (the access code is available from the PROLIST Office).

The aims of the LOPs of NE 100 are:

- To define a common language for customers and suppliers through the publication of LOPs.
- Through the application of NE 100, to optimize workflows between these partners and within their own organizations in engineering, development and purchasing processes, among others.
- To reduce transaction costs.

The process of international standardization of NE 100's content with IEC is underway. Firstly, cooperation was arranged between PROLIST and ISA taking the ISA SpecSheet TR20 into account. Secondly, an IEC working group was established to bring the PROLIST LOPs up to international standards. Part 10 of IEC 61987 is already available. The IEC working group is working now on Part 11 and further parts.

## 2. Structure and features of lists of properties

Lists of properties to specify devices and systems are now state of the art based on well-established standards, norms and guidelines. The data model on which they are based is described in the IEC 61360<sup>[3]</sup> and ISO 13584<sup>[4]</sup> series of standards.

Literature:

- [3] IEC 61360 "Standard data element types with associated classification scheme for electric components"
- [4] ISO 13584 "Industrial automation systems and integration – Parts library"

## 2.1 Properties

Properties are specific features serving to describe objects, such as process control devices. These features include requirements and basic conditions which are either imposed by the environment in which the device is to

operate or which should be taken into consideration. They also include all the device's technical details.

The property itself is defined by the attributes assigned to it, such as identification (ID code), preferred name, definition, unit, and format (see Figure 2).

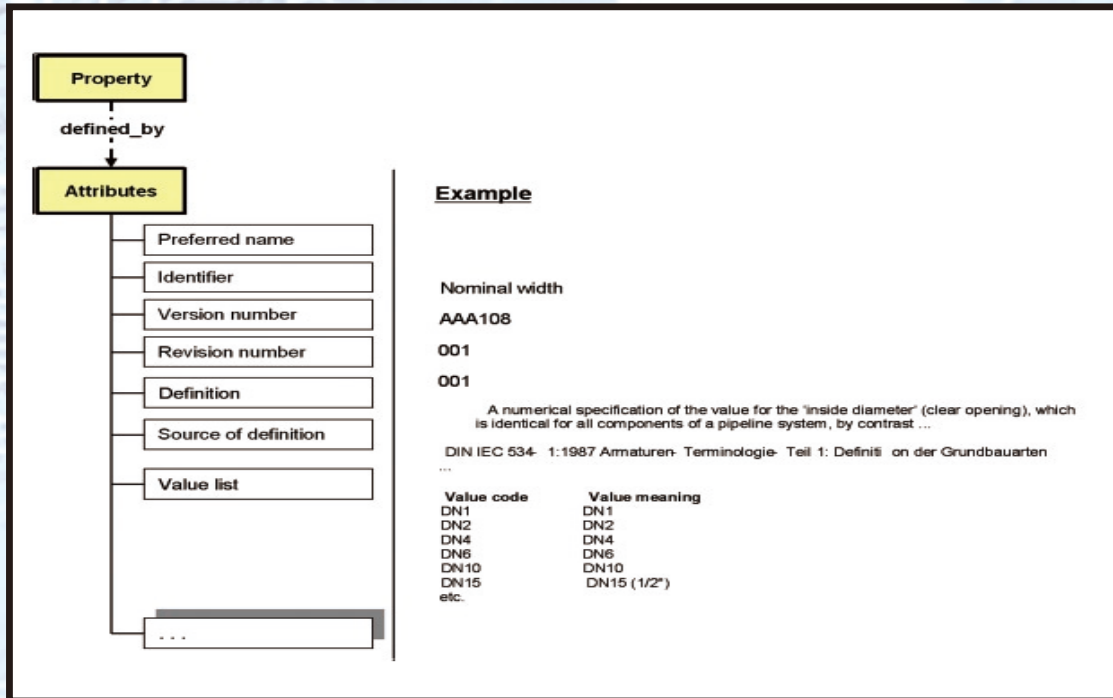

Figure 2: A property and its attributes

## 2.2 Lists of properties with block structure

A list of properties is a compilation of characteristics. When all the properties of equal importance are arranged on a single level, we call it a linear list of properties. As more and more properties are added the list becomes increasingly confusing but clarity can be restored by structuring the properties in blocks.

A block of properties can consist of one or more properties. It can also contain one or more subblocks (see Figure 3). A block is a grouping of properties describing an abstraction from a complex feature of a device type. Blocks can be assigned to the necessary level as dictated by the technical requirements. However, when a list of properties is compiled, an effort is made to keep the hierarchy as flat as possible. At the lowest level, subblocks will contain only properties.

If subblocks are present, a reference property is included in the higher-level block to refer to the respective subblock. The block structure within the list of properties is illustrated by the UML schema shown in Figure 4.

The attributes of blocks are structured in a similar way to the attributes of properties and thus include an ID code, a name and a definition.

The block structure makes it easier to create new lists of properties. Once a block has been defined, it can be repeated at various points in the same list of properties. For example, the electrical output block can be used for both analog and binary outputs. An individual property can assume a different meaning depending on its position within the list of properties, i.e. into which block it has been inserted. Similarly, a block itself can also assume a different meaning.

The cardinality of a block of properties is a structural expression which defines whether and how many times

a block is to be used within an LOP or whether it is to be omitted.

If the properties in a block of properties are required more than once in an LOP (e.g. to cater for several analog outputs, channels or process connections), the structure of the block is defined only once. When generating the transaction data for a specific device, the value assigned to the counting property then defines how often that particular block is to be repeated.

The cardinality function defines the relationship between a counting property, the value of which determines block repetition, and a reference property referring to the block in question.

In the example shown (see Figure 3), the cardinality function is assigned to the "number of process connections" property in order to control the repetition of the "process connection" block of properties.

When preparing the transaction data, the user determines how often the "process connection" block of properties is to be used by entering a positive integer in the "number of process connections" property. If zero is entered, the block will be omitted.

Structural concepts, such as views, polymorphism and composite devices, are described in greater detail in NE 100 [1].

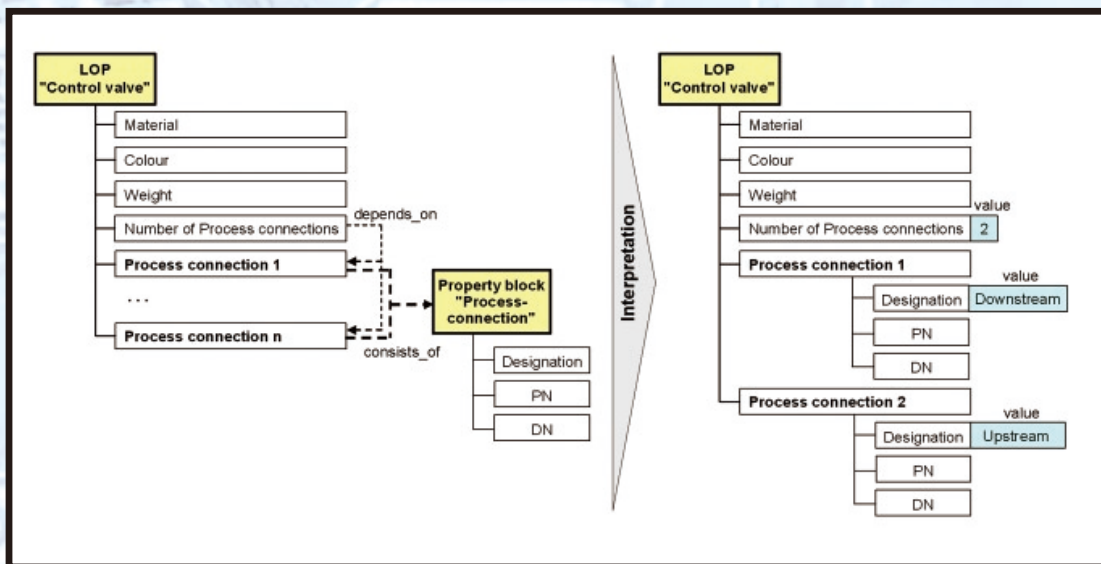

**Figure 3: Example of block structure and cardinality, illustrated by part of an LOP.**

### 2.3 Types of lists of properties

Most classification systems that use lists of properties concentrate exclusively on describing the technical features of a device type. NE 100, on the other hand, makes it possible to take account of other aspects.

In NE 100, these aspects are described using certain types of lists of properties.

- Device List of Properties (DLOP), describing the technical features of a device

- Operating List of Properties (OLOP), describing the operating aspects, i.e. ambient conditions,
- Administrative List of Properties (ALOP), describing all the information needed for data exchange,
- Commercial List of Properties (CLOP), describing all the applicable commercial data.

The structure of the LOPs provided in NE 100 can be represented using the schema shown in Figure 4, which is based on the Unified Modeling Language (UML) [5].

Literature:

[5] CWA 15295: 2005-08 "Description of References and Data Models for Classification"

The Administrative List of Properties (ALOP) should be used whenever transmitting transaction data. It contains header data, i.e. information about the type of document (e.g. inquiry, offer), and the issuing details for the transaction (e.g. author's contact data). For an inquiry, the ALOP will contain the customer's properties and organizational and administrative information required to process the inquiry. The ALOP of the offer prepared in response to an inquiry will contain the properties relating to the supplier with the corresponding data.

The Operating List of Properties (OLOP) contains the main data relating to the device's operating environment (ambient conditions). It also contains the data required for device design. All basic operating requirements are contained in the OLOP. In an inquiry, the customer will specify the required ambient conditions (e.g. maximum ambient temperature) in the OLOP for correct device selection.

These requirements on a device correspond to the properties that are used to describe a process operator in a formal process description, as specified in VDI/VDE Guideline 3862<sup>[6]</sup>.

The Device List of Properties (DLOP) is used to describe a device and thus serves as a compilation of the main results of a development by a manufacturer and to support

e-commerce as well as applications in CAE and ERP systems. It is also useful for maintenance purposes (e.g. when updating and upgrading versions).

At the beginning of a procurement process, the customer can build an "inquiry view" in the DLOP and use this view to enter their technical requirements. In practice, when a DLOP is in the inquiry view, it will contain only a few entries. The supplier, however, may use the DLOP to its full extent if he wishes to provide the customer with a full description of the proposed device. The DLOP also contains CAE-relevant properties that can be imported to a CAE system as master data for a device.

Within the meaning of VDI/VDE Guideline 3682<sup>[6]</sup>, the DLOP corresponds to the properties for technical resources. The structure of the blocks in the DLOP roughly reflects the structural specifications defined by the IEC 61987-1 standard<sup>[7]</sup>.

Figure 5 illustrates the difference in meaning when a property is used in a DLOP and an OLOP taking as an example the installation of a measuring device in a pipeline. The properties for nominal diameter (DN) and nominal pressure (PN) are used in the OLOP to describe the operating environment (pipeline), whereas in the DLOP they characterize essential features of the device used.

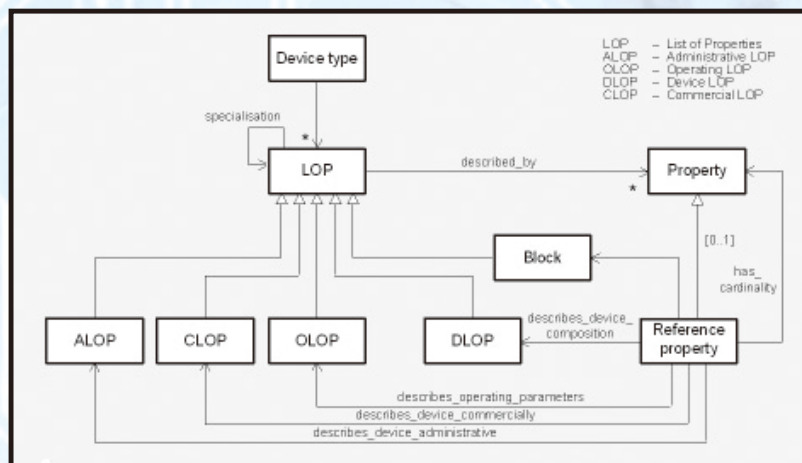

**Figure 4: Simplified UML schema of an LOP**

Literature:

- [6] VDI/VDE 3682: 2005-9, Guideline "Formalized process description", Berlin Beuth Verlag
- [7] IEC 61987-1: 2006-11 "Industrial-process measurement and control: Data structures and elements in process equipment catalogues - Part 1: Measuring equipment with analogue and digital output"

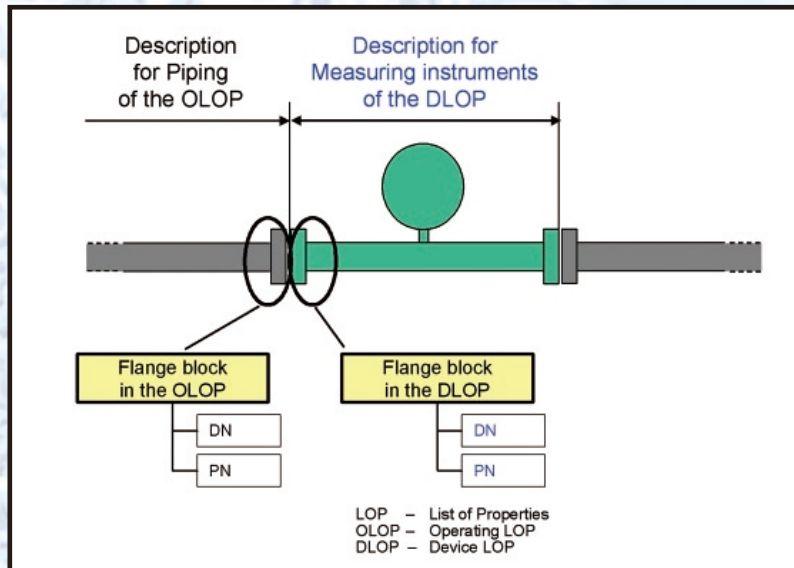

**Figure 5: Interrelationship between properties in the OLOP and DLOP**

The Commercial List of Properties (CLOP) contains data such as prices, delivery times, transport information, and order or delivery quantity that are important for business workflows. In other words, the CLOP contains the commercial aspects of an offer.

In addition to the types of LOPs mentioned above, preparation of further types of LOPs is planned covering other important aspects of the engineering workflow, such as maintenance and installation, for inclusion in future versions of NE 100.

### 3. Use of lists of properties in the engineering and business workflow

The use of LOPs in the engineering workflow is based on the workflow for process control projects as shown in NA 35<sup>[8]</sup>. The pre-engineering, inquiry generation, offer generation, selection and detail engineering stages will be discussed here by way of an example. Figure 6 indicates which types of LOPs are used at each stage. These LOP types are shown in bold type with a grey background.

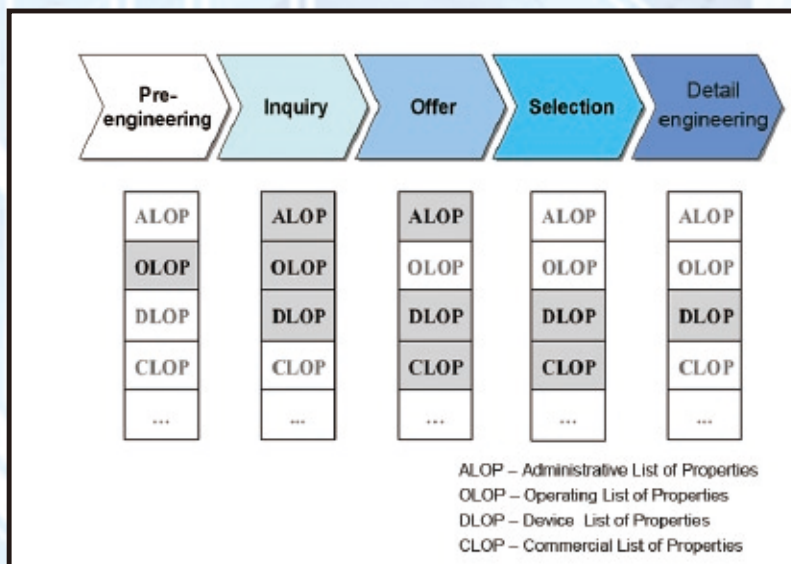

**Figure 6: Use of LOP types at individual project stages**

Literature:

[8] NA 35: 2003-03 "Handling PCT Projects"

The application of NE 100 is explained using the following workflow (Figure 7). The workflow is to be largely automated. When preparing an order or a technical inquiry, the customer proceeds as follows:

- They must have access to a tool that is capable of handling the lists of properties, e.g. a CAE tool.
- They select the appropriate device type (list of properties) for their specific application.
- They enter the inquiry data into the input masks provided by the tool. These will generally be the ALOP, the OLOP and the DLOP.
- The tool generates an XML transmission file (transaction data) according to NE 100, which they send via the Internet to one or more suppliers.

Modern CAE systems consist of several modules: a module for process engineering, including the P&I diagrams, a module for the piping systems, and a module for the process control equipment. When a new loop sheet is created, the process control module can import the required data from the processing engineering module. This relieves

the process control equipment planner of many manual input tasks while enhancing data quality.

The transmitted information is used by the supplier to generate an offer. He adds more data to or changes the contents of the DLOP. In addition, he adds his own ALOP and, above all, a CLOP containing the commercial details. He then sends this offer to the customer in the form of an XML transmission file.

The customer can now compare offers received from different suppliers and select the most appropriate for his order. Because each property has been assigned a unique ID code, the values for the properties contained in the offers can be easily evaluated by computer. The customer can also use the data transmitted by the supplier(s) to generate their own plant or system documentation. As a result, they not only have a record of the device requirements but also obtain detailed documentation of the device actually selected, which they can use for reordering or refer to when clarifying any specific questions relating to that device.

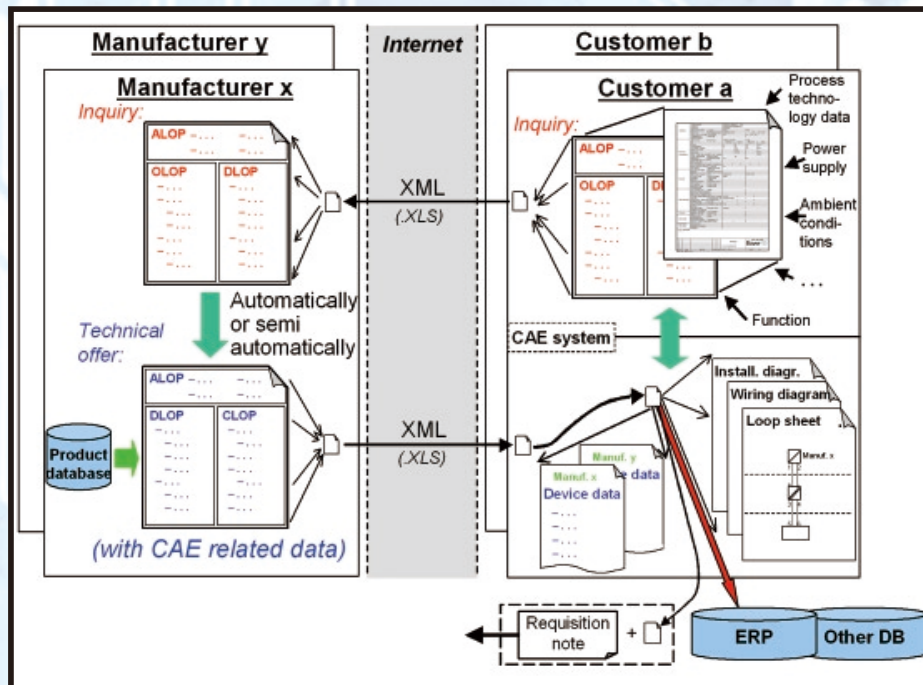

**Figure 7: Data exchange in the engineering workflow between customer and manufacturer**

To ensure the repeatability of the described workflow, both the suppliers and the customer must have an appropriate technical infrastructure.

It should be pointed out that XLS formats can also be used initially instead of the XML transmission files described, if the infrastructure required for XML applications is not available at the user's company. However, the achievable degree of automation will be well below that of the recommended XML files. The XML file has been defined by SAP, Paradine and PROLIST.

The following principle is implemented in the workflow shown in Figure 7. All the data that have to be entered in an IT system for a specific process control device or system should only need to be inserted once in the entire chain of subprocesses in the workflow. Adherence to this principle considerably enhances the quality of data processing.

The main objectives of LOPs in the engineering workflow are summarized below:

- To describe the operational and functional requirements on a process control device.
- To enable a device supplier to submit an offer for a suitable process control device based on these requirements.
- To order devices through a procurement/purchasing system.

- To document the data of a process control device in a structured manner.
- To provide device data for planning purposes using CAE tools.

### 3.1 Structural and transaction data

The structural data for each device type are determined by the LOP for that device type. The data for this LOP come from the OLOP or the DLOP (see also Section 2.3). The structural data determine the sequence of the properties or blocks of properties and the arrangement of these structural elements, which are indexed accordingly.

For installed devices or for requirements on devices to be delivered, transaction data are exchanged between customer and supplier or between different technical departments within a company. This means that values are assigned to the properties defined in the structure and these values are then transferred to an XML transmission file for transfer.

The use of structural data to generate transaction data is explained below based on an example and illustrated by Figure 8.

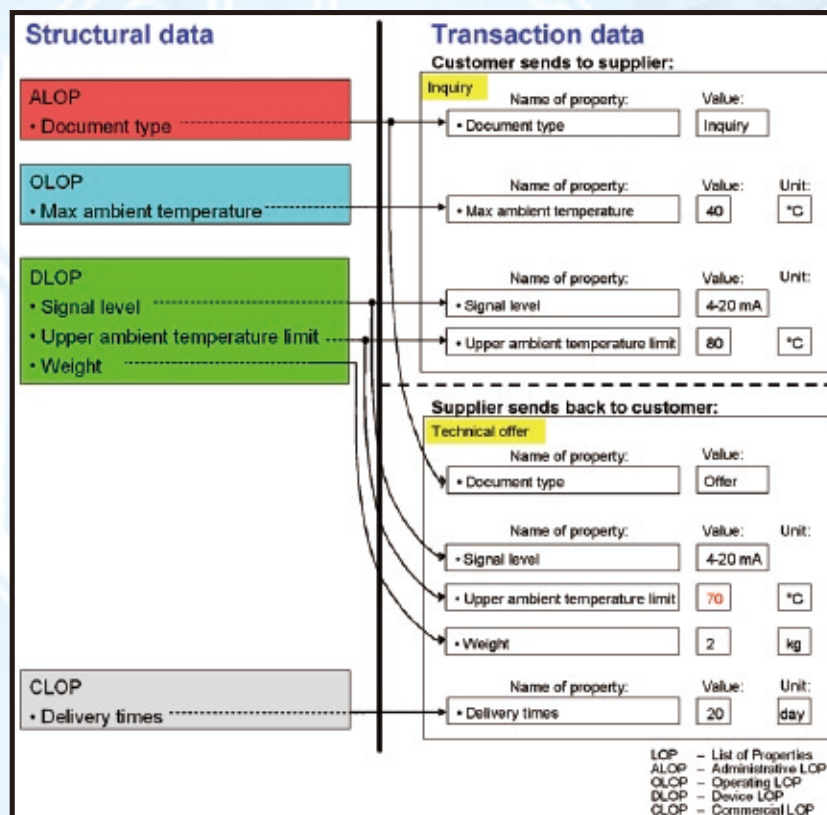

Figure 8: Structural and transaction data for inquiry and offer



## 4. Infrastructure – the basis for use

In order to use the NE 100 LOPs within business processes between companies system support is essential. At present several CAE system suppliers have already implemented or are working on implementing the NE 100 LOPs in their systems. Furthermore, PROLIST provides the systems described below <sup>[9]</sup>.

The PROLIST database (server) is an online dictionary which is available to PROLIST members. It is accessible through a standard internet browser via the Web. No local installation is necessary. Companies may download NE 100 LOPs in different file formats (XML, xls or pdf). New LOPs are also generated online in the system with a workflow engine supporting the joint development of LOPs for new devices. The PROLIST database is based on the Online Reference Dictionary developed by the Vienna-based Paradine company for PROLIST.

PROLIST supports the creation of device inquiries for suppliers or offers to be sent to customers based on the NE 100 LOPs. If the companies do not (or do not yet) have their own systems or infrastructure to process the NE 100 LOPs, they can use the PROLIST User Package based on the PROLIST database which allows users to evaluate and store NE 100 LOPs.

PROLIST also assists users in processing NE 100 LOPs on their own systems with PRO-SPEC, an offline tool. PRO-SPEC is a Windows application. It was developed by PROLIST and implemented by Paradine and supports the NE 100 LOP structure. Evaluated NE 100 LOPs can be created, edited, compared and exported in XML and xls format. PRO-SPEC became a key tool for the LOP technology. It makes an easy start of the LOP technology for everybody especially when the own company do not have an appropriate infrastructure. PROLIST members can get PRO-SPEC by strong reduced prices. For non-PROLIST members it can be purchased through the PROLIST Office (e-mail:office@prolist.org).

## 5. Summary

PROLIST's members are seeking to exploit this unique opportunity to optimize their internal and external processes and workflows and to reduce transaction costs in engineering and procurement by utilizing lists of properties. Initial experience of using LOPs in engineering workflows has been already gathered in pilot projects <sup>[10, 11]</sup>. PROLIST companies are now preparing for the operational launch of LOPs, including commercial data.

CAE systems in particular play a decisive role in the practical application of NE 100 on the customer side by supporting and increasing planning efficiency. The CAE systems used in the planning process must meet essential requirements arising from the engineering workflow under NE 100 (Figure 7).

One important condition is that all documents in the form of XML transmission files, for example, should be capable of being exported from and imported to the system. It should also be possible, as envisaged by NE 100, to import CAE-relevant data such as terminal designations. The CAE systems should be able to automatically accept the master data of a new device type. Another important factor is the ability to compare the technical device data from several offers in the same CAE system.

The exported and imported files thus help to increase data quality in the context of integrated electronic data exchange with other systems, including ERP systems (such as SAP).

Throughout the life cycle of a device, data about the device are exchanged between the various departments concerned, including process and process control planning, operations, maintenance and procurement data on the customer side or sales, marketing, development and after-sales service data on the supplier side. The complex workflows associated with this information exchange are illustrated in Figure 9 below:

---

### Literature:

[9] Ahrens W., Löffelmann G., Zgorzelski, P.: "Produktdatenaustausch auf der Basis standardisierter PROLIST-Merkmalisten für PLT-Geräte und -Systeme", atp – Automatisierungstechnische Praxis 47 (2005) Heft 7, S.25-31.

[10] Löffelmann, G., and P. Zgorzelski. "Lists of Characteristics for Optimization of the Processes in Automation and Process Control." Proceedings of ISA EXPO 2004, Houston

[11] Zgorzelski, P. "Implementation of the Lists of Characteristics of NAMUR Recommendation NE 100" Proceedings of ISA EXPO 2005, Chicago

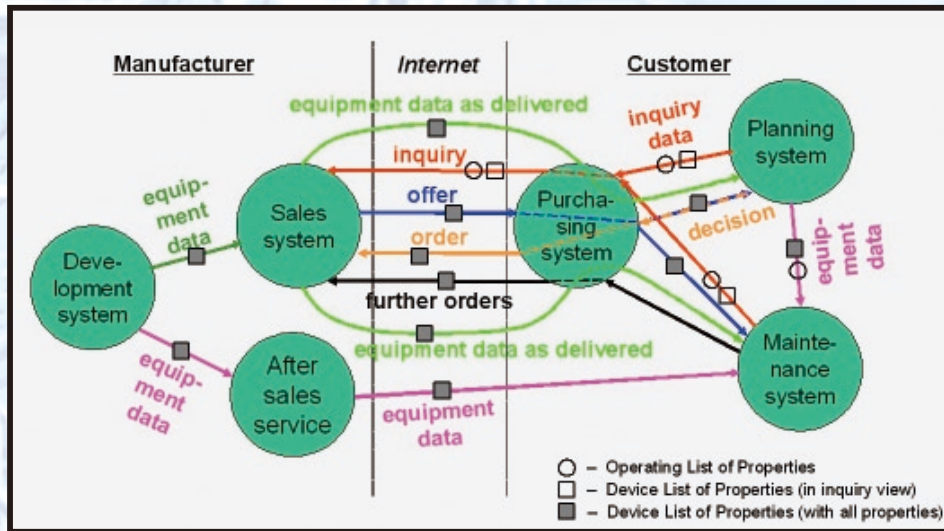

**Figure 9: Data exchange throughout the life cycle of a device**

The use of standardized and harmonized properties and the associated values can optimize processes both between suppliers and customers and within their own companies.

In its simplest form, NE 100 provides specifications for

process control devices and systems with defined properties. When applied to its full extent, NE 100 can form the basis of structures and interfaces in ERP, maintenance and CAE systems, and process control systems, as well as user/supplier marketplaces.

**Authors:**



**Dr. Günter Löffelmann**, studied physics and chemical engineering as well and gained his doctorate in process engineering. He has had different positions as chief of a process control department, process engineering department and purchasing department. He was Vice President of an US Bayer subsidiary and conducted different international projects, e.g. in China. Now, he heads the Global Procurement of Bayer Technology Services GmbH. He works in and heads a national research committee and published some papers and patents. He was chairman of the NAMUR Project Group "Lists of Properties" (PROLIST®) till 2007 and is active in working groups of NAMUR, eCI@ss, and DIN.



**Prof. Dr. rer. nat. Burkard Polke**, studied physics and gained his doctorate in this area as well. Now, he is a lecturer at the Rheinische Fachhochschule Köln University of Applied Sciences. His main subjects are physics, technology of measurement, process control engineering, and process and fluid technology. He was member of the "Lists of Properties" Project Group (PROLIST®) Steering Committee. He specializes in formalized process description and integrated engineering.



**Dr. Peter Zgorzelski**, studied automatic control engineering and gained his doctorate in closed-loop control technology. He joined Bayer AG in 1989 and managed numerous projects at Bayer AG's Uerdingen site. He was then responsible for the procurement of process control equipment at the Central Technical Purchasing Department in Leverkusen. Now, he works in the Process Management Technology staff unit at Bayer Technology Services GmbH and is Office Manager of PROLIST® INTERNATIONAL. He is active in NAMUR, eCI@ss, DKE and IEC working groups.